

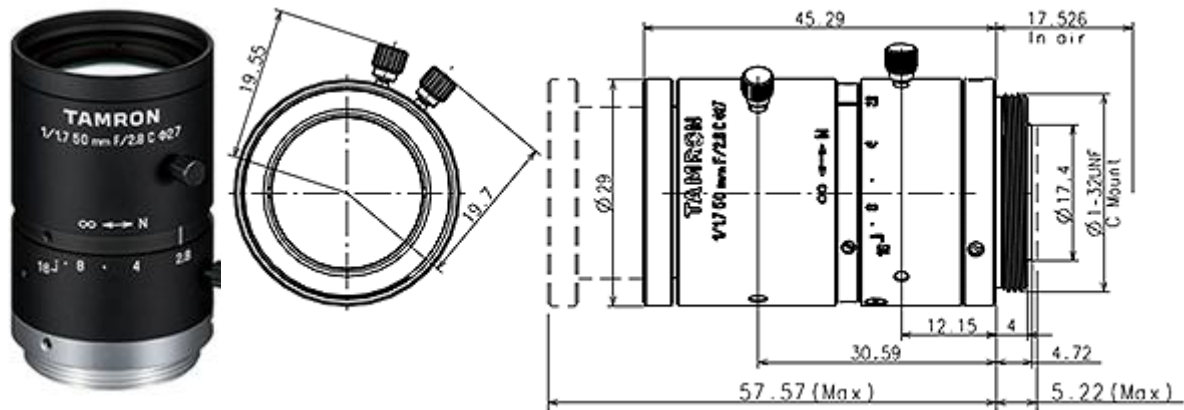

M117FM50



SPECIFICATIONS

		M117FM50
Imager Size		1/1.7
Mount Type		C
Focal Length		50mm
Aperture Range		2.8 - 16
Angle of View (Horizontal x Vertical)	1/1.7	8.9° x 6.7°
	1/1.8	8.7° x 5.9°
	1/2	7.5° x 5.7°
	1/3	5.7° x 4.3°
TV Distortion		-0.01% (Design Value)
Focusing Range		0.2m - ∞
Operation	Focus	Manual with Lock
	Iris	Manual with Lock
Filter Size		M27 P=0.5mm
Wave Length		Visible Light
Weight		60g
Operating Temperature		-20°C - +60°C